

4.5V-60V Vin, 3.5A, High Efficiency Step-down DCDC Converter with Programmable Frequency

- + 4 5%
- % 1 %
- (4 / 15(4 /
- + * 5
- . 3 %
- 2 5 / 25/
- / 1
- + 5
- (- * / *
- % 5
- 2 2 1 2
- + . 1 * . 1 2
- . & / 1
- & + 4
- 1 1 2
- 51 2 2
- + 2
- 5
- + / %
-

01 2
4 2

5%	5	1) (4	5	4	5%	5	4	512
----	---	------	---	---	---	----	---	---	-----

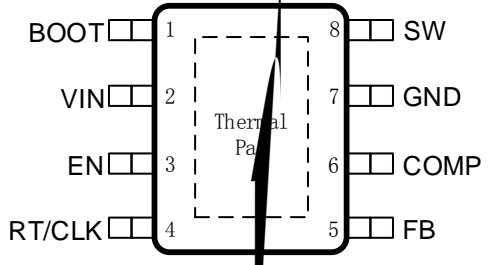
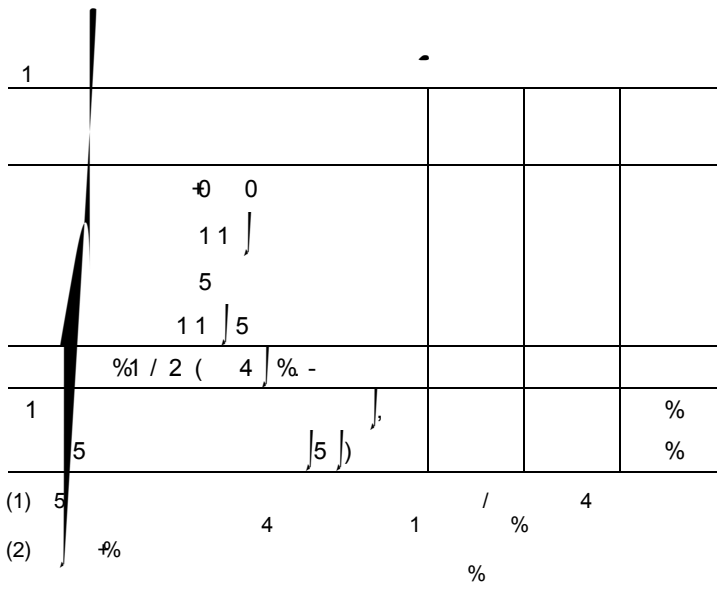

11	2	/ 15(%	(
0	11	5	5	0& 2
0	0	0&	0	0& 2
4 % -	5	4 % -	2.. +	%
(
%1 / 2		%		
) 0&)			

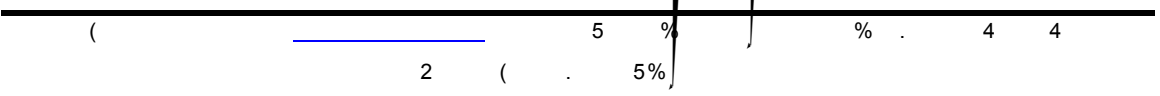

5		4	%	5
2		*	2%) 0& /

1

0	+			
1	1			
,	1			%

5&		* / * / 05+, & %, 5		
		% & / %&/ 05+, & %, 5		
(1) , & %	, 2	* /		5&
(2) , & %	, 2	%&/		5&

	,			%
	,			

0	%	%	%	
---	---	---	---	--

0	1			
0 .1	+ .1		0	
t* & 0	5	0	0	
t	3	0	11 5	

4&510 *	* / 15(11	5	
---------	---------	----	---	--

4 (4 (
)		t%1 / 2	%1 / 2	5
t%1 / 2 54%		(4 (%1 / 2	
t%1 / 2 50-		(4 (%1 / 2	



%1 / 2 *	%1 / 2			
%1 / 2 .	%1 / 2			
+4 *5	*	/ 15()		
0 *				
+0 .		0		
+0 *		0		
55	5			
(4 0) 4]	(4]		*
(5	5	4 4]		*
10 / 0	/	0		
1 2	((4 (
11]	11] 5 .1	(4 (
5&]	11] 5		%
		*		%

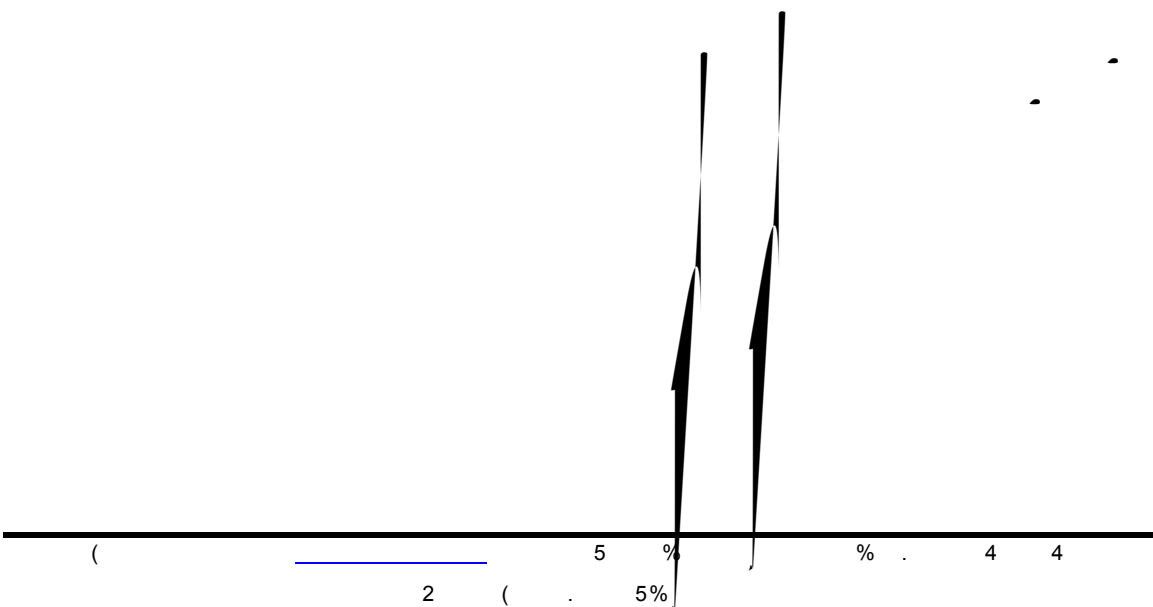



(. % (

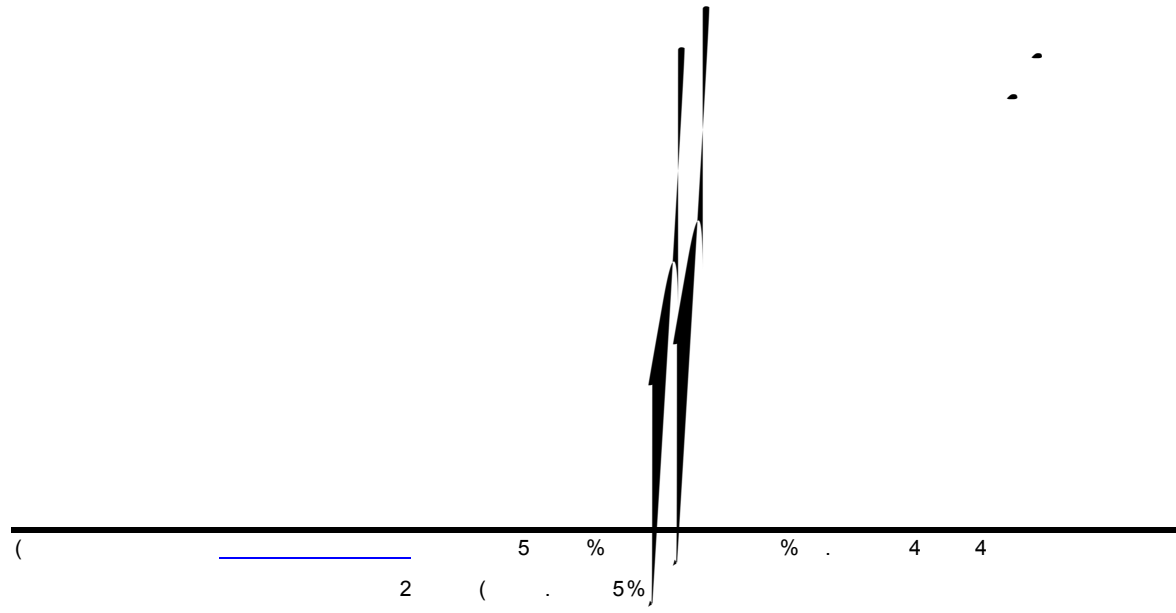

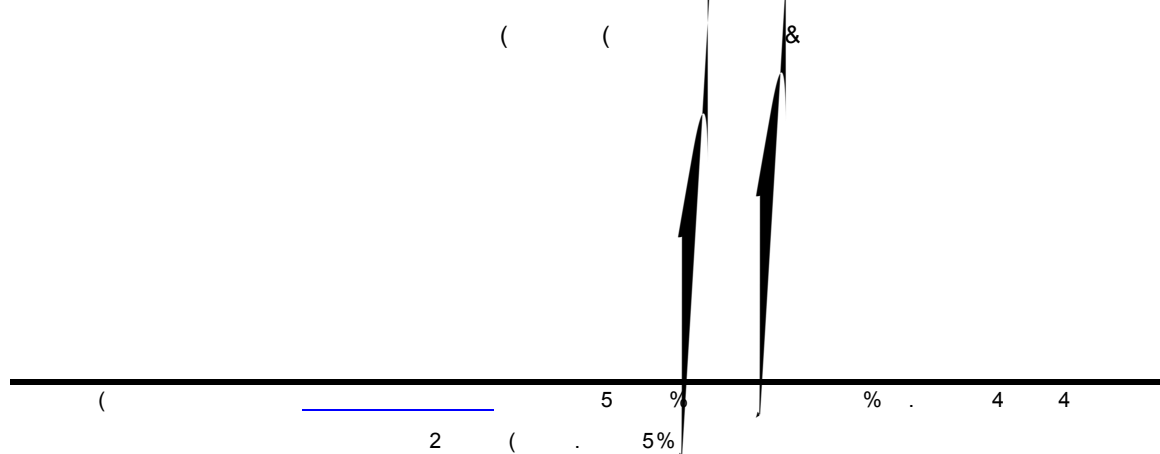
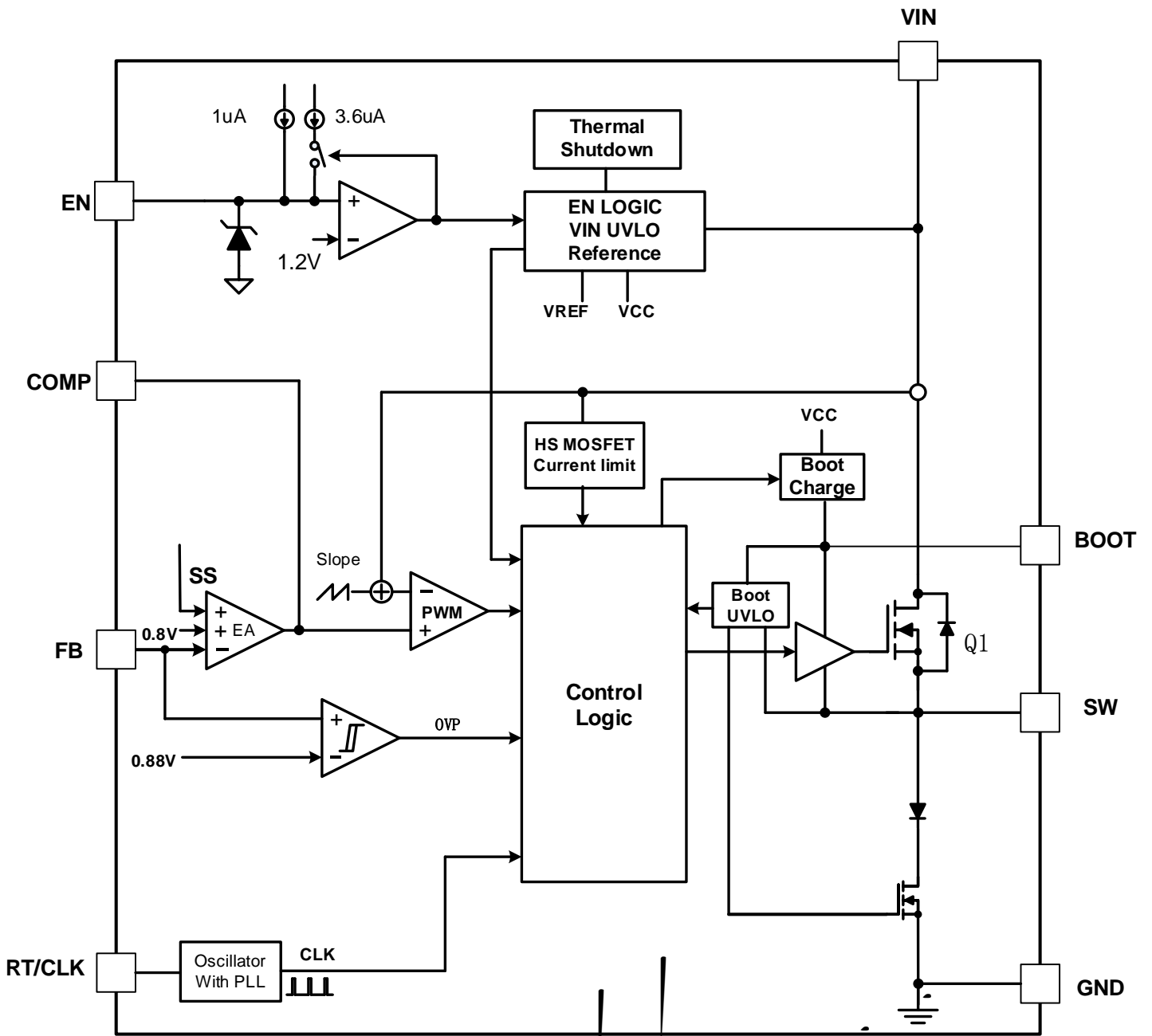

5%
/ 15(+

4

* / *

5%

2 /

25/

5%

0

% .1 0 +0 (0

5%

5%

/ 15(3

%1 / 2

/ 15(
/ 15(

%1 / 2

(

%1 / 2

5%

2 5 / 25/

%1 / 2

%1 / 2

25/

1 (

%1 / 2

/ 15(
%1 / 2

5%

+0

+0

0

0

0

0

(

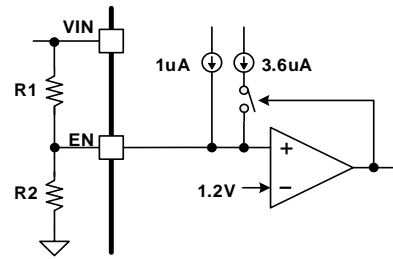

• .1
 • .1
 (5 .1

5% ±1% tolerance (+

*
 ()

• 4(1.2)
 • 4(1) ()

5% + 0

5% 4 % -

(2 (5%) 4 4

+

(

(

2

(

5

%

5%

%

4

4





.
 + &%
 /
 1
 &
 + (
 %
 (

5% 1 2 1 2 1 2
 (/ 15((/ 15((

5% % / 15(1

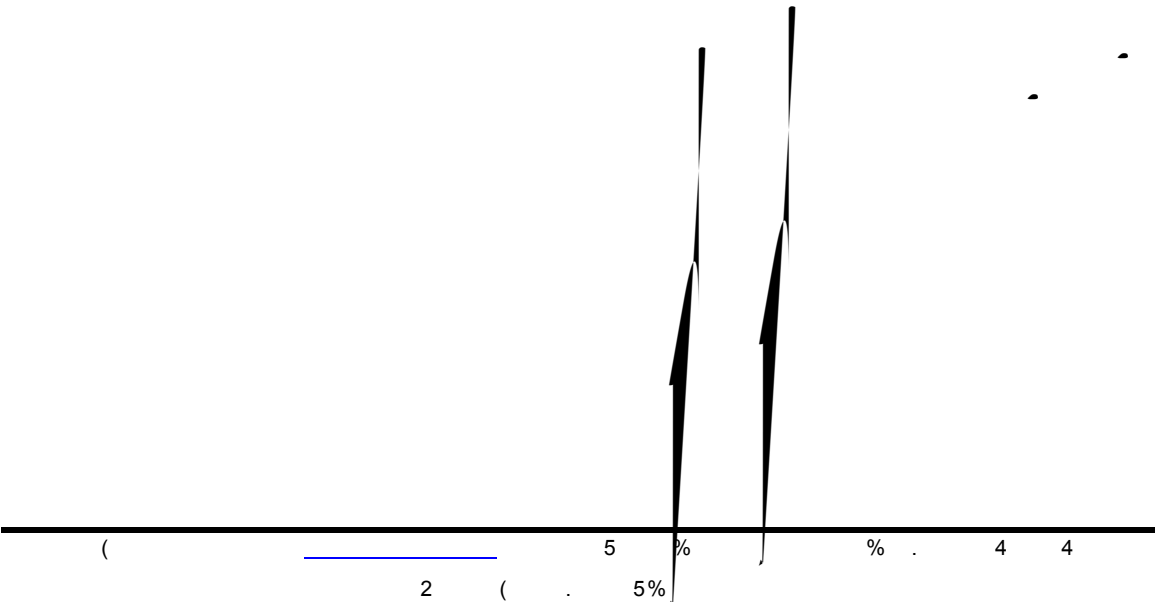

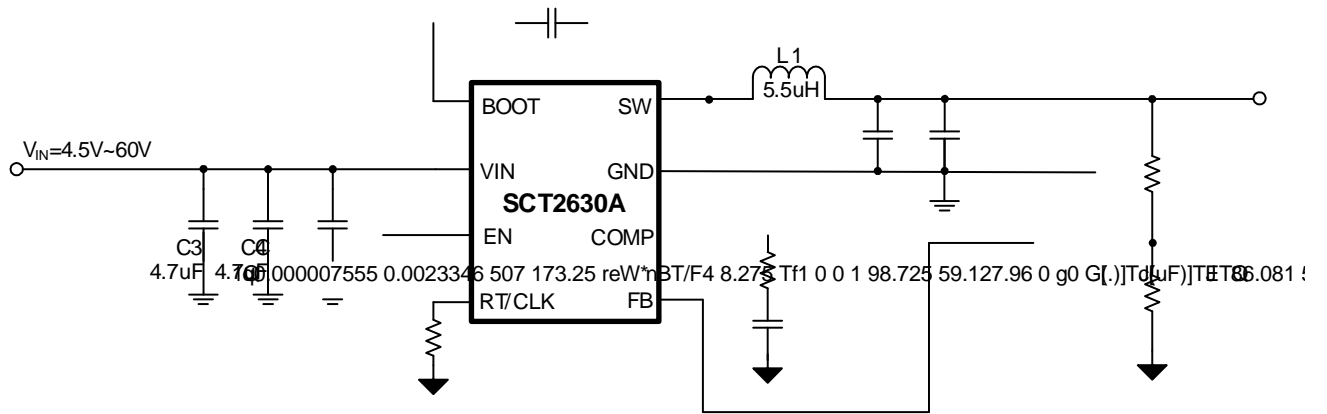

2

+			0
1			
/	1	%	
5	(- *
1			
	4		
5	+	0	
5	+	0	

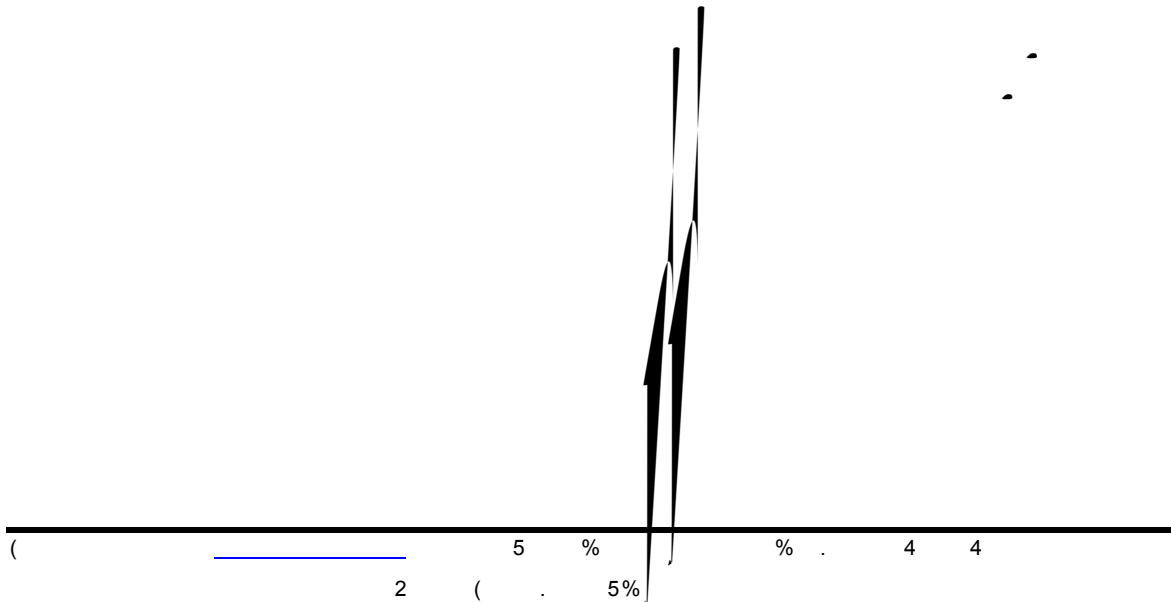

4 4
4 4 4

	-	-
	-	-
	-	-
	-	-
	-	-
	-	-
	-	-
	-	-

• 4 (

* * + *

4 % -) 0&

- *	-
- *	-
- *	-
- *	-

• 5

. 1 4 .1 0 .1 4 0 (

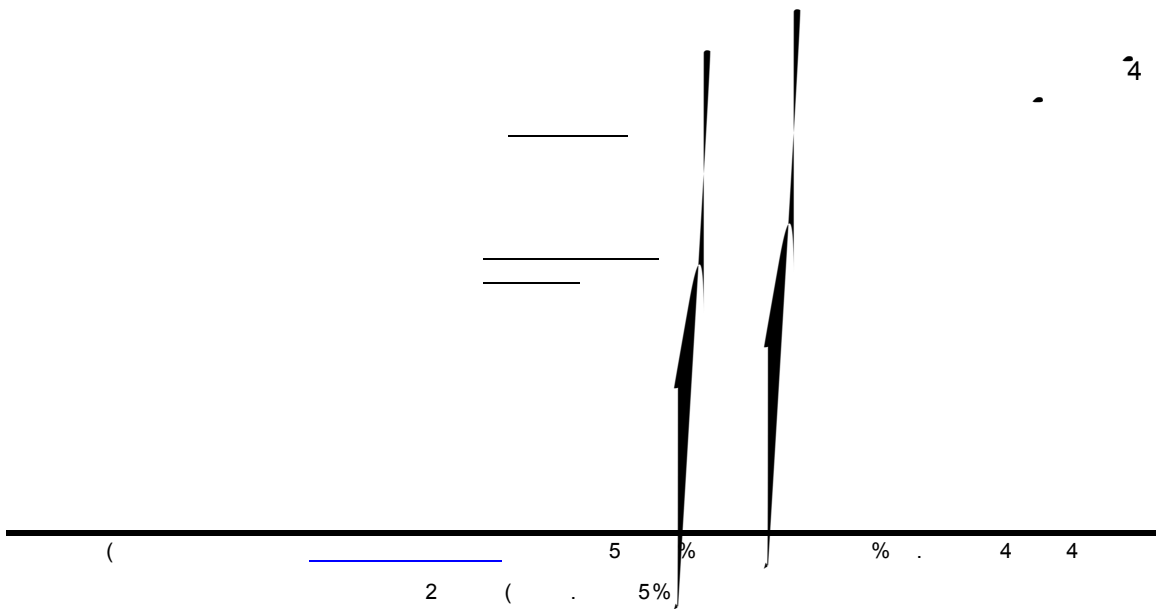

4 / 5

&%

&%4

+22

- +22
- .
- 5
- 1
- 0

5

- . / €
- .
- 1
- 0
- †
- . 4

&%
+22 †

4 / 5

+2 - +4 / 5

- +2
- †
- +22
- +4 / 5

&%

4 / 5

+

5%

+2 -

5%

5

) 0&

5

0

5%

(

% (5

% (

% (

(

+

%

%

&%&%
&%&%

4

4

&%

54

54

(

0) 0&

2

4 / 5

0

1

4 / 5

(

(

2

(

5

5%

%

%

4

4

()

&%

%

- 4₁
-)
- 4.1 &

5

4 %

54

54

+

54

%

4

%

4

%

&

%

)

%

54

(

2

(

5

5%

%

%

4

4

(



;

5%

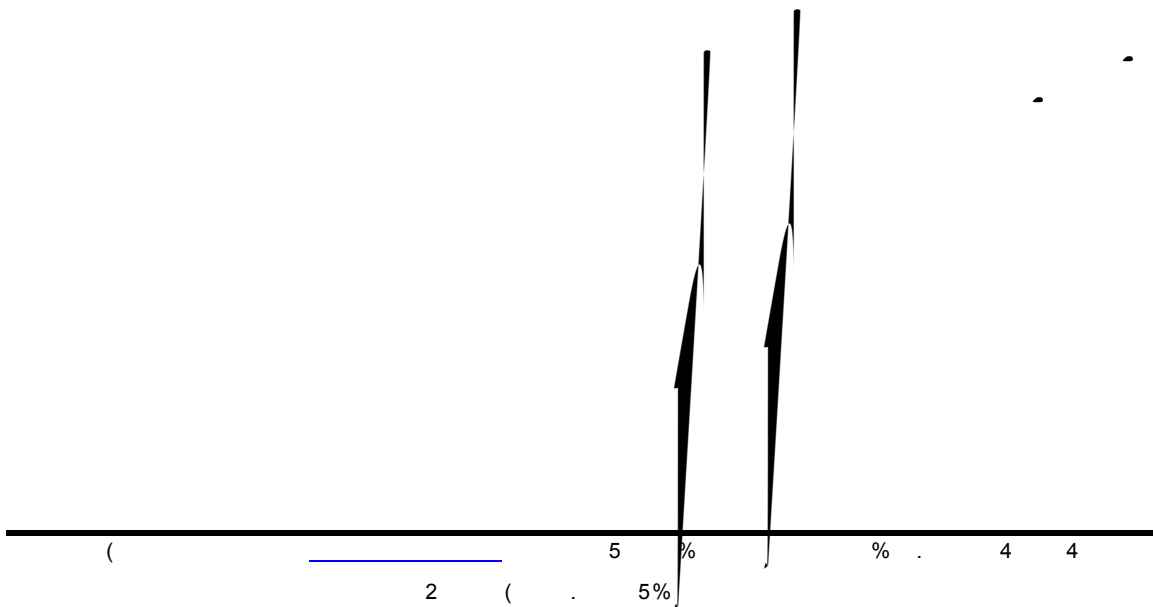
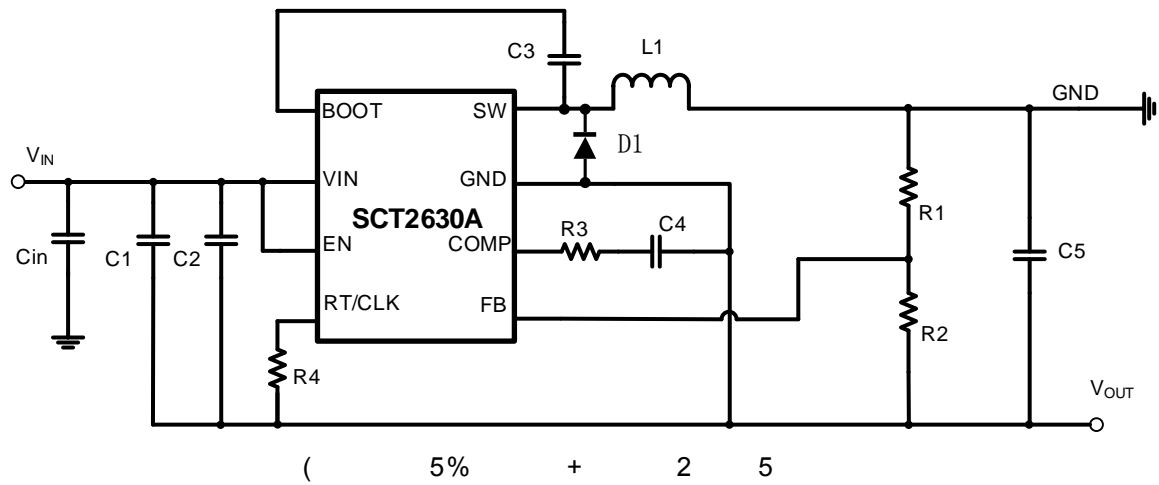

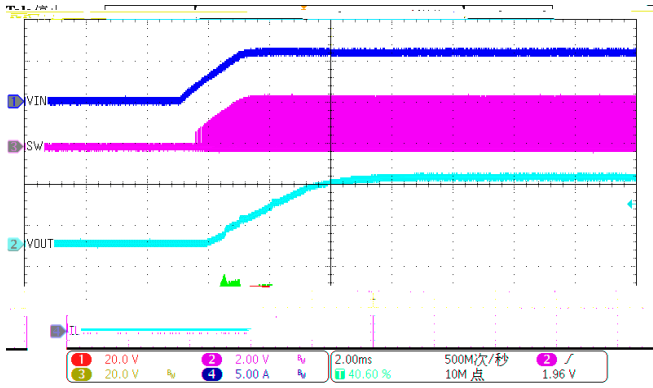

(2 +

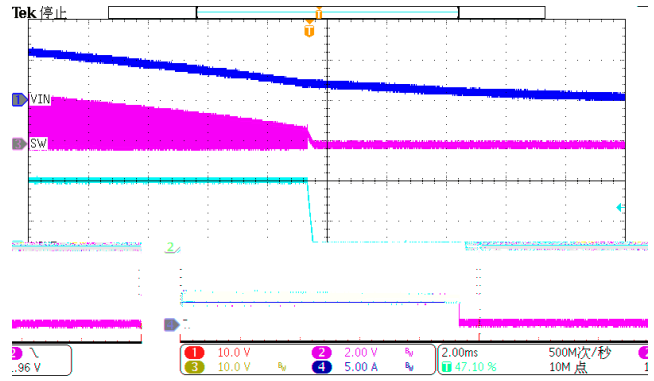

(2 +

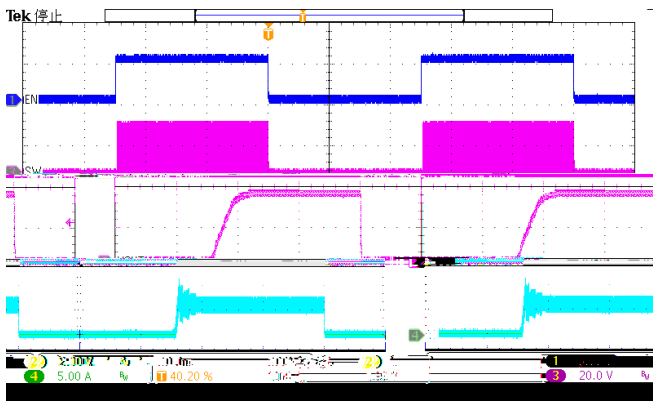

(0 +

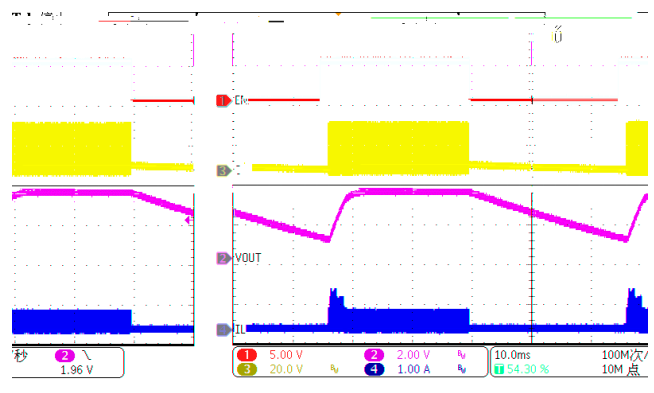

(0 +

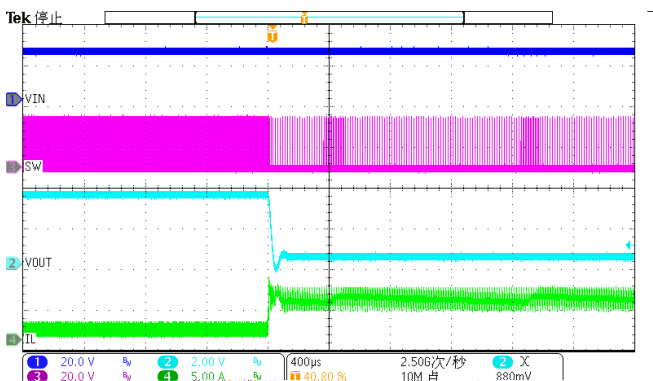

(1 % 2

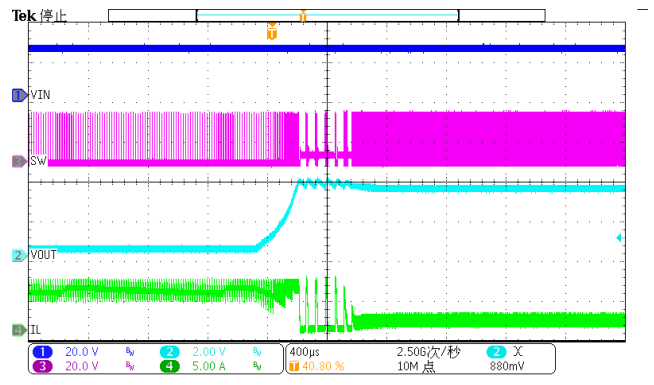

(% 4

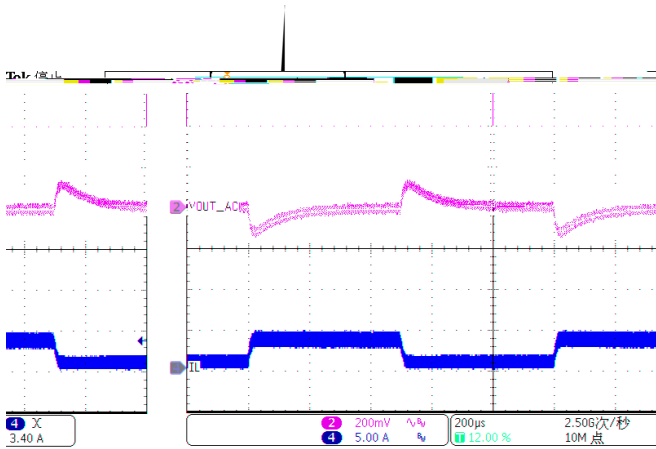

(.)

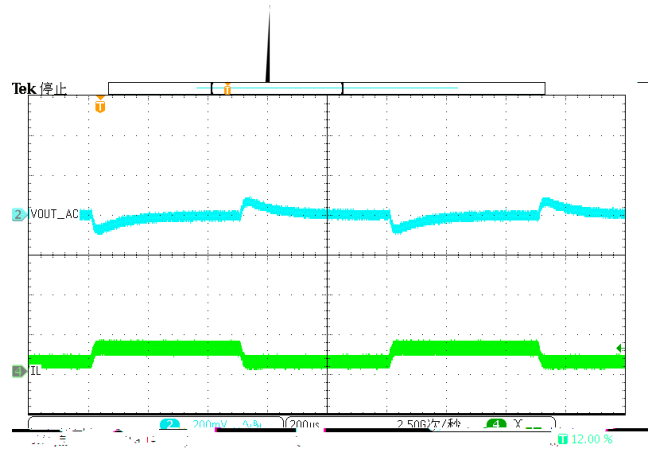

(.)

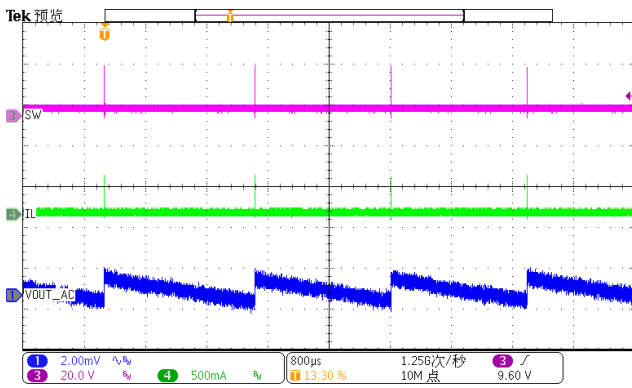

(1 4 +)

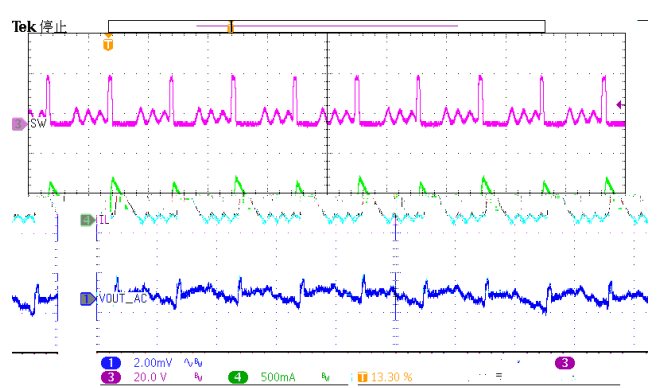

(1 4 +)

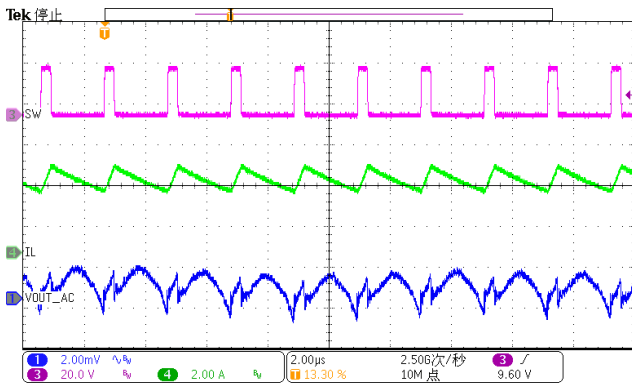

(1 4 +)

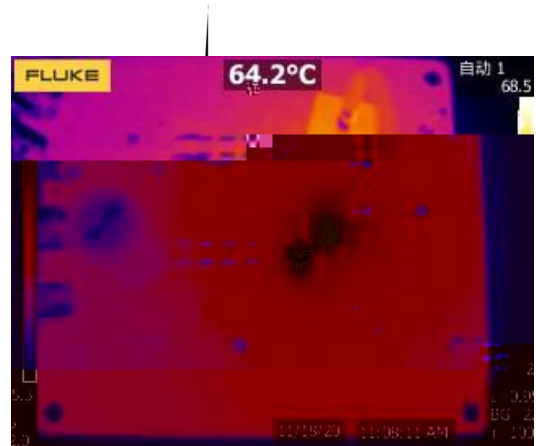

(.) 0

(.) 5 % 2 (.) 5 % 4 4

1	&	2	2	523
5%	5 4	51 2		

