

3V-40V V_{in} , 300mA, 2.4 μ A I_Q , Low-Dropout Regulator with PG Feature

±

±

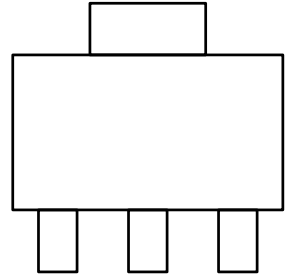
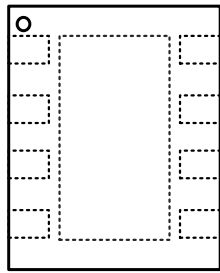
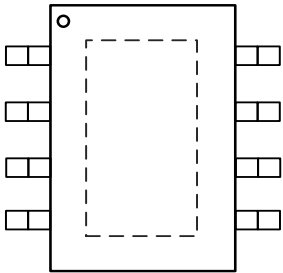
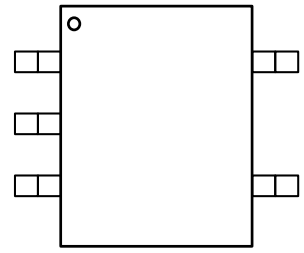
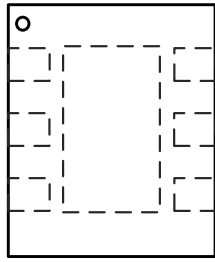
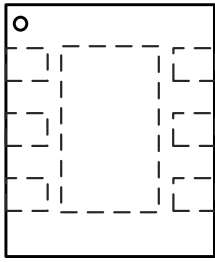

(1)

(2)

- (1)
- (2)
- (3)

- (1)
- (2)

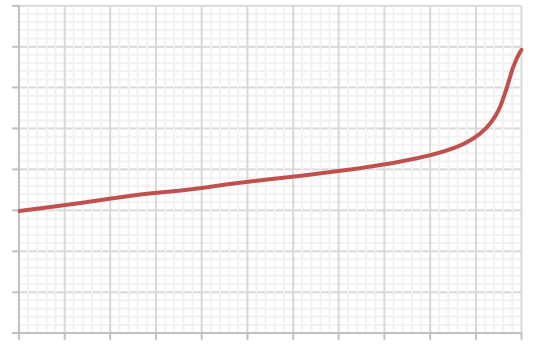
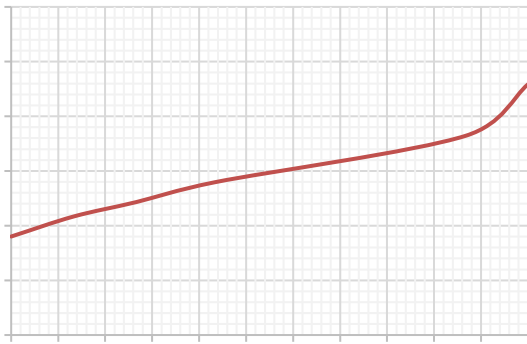
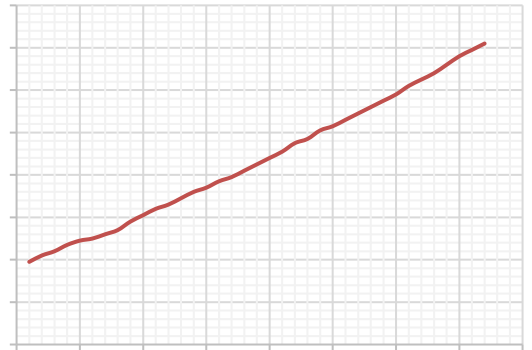
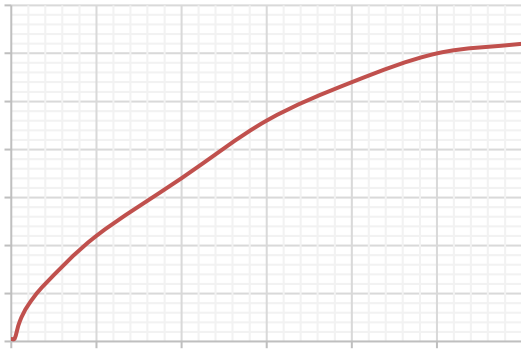

°C

°C

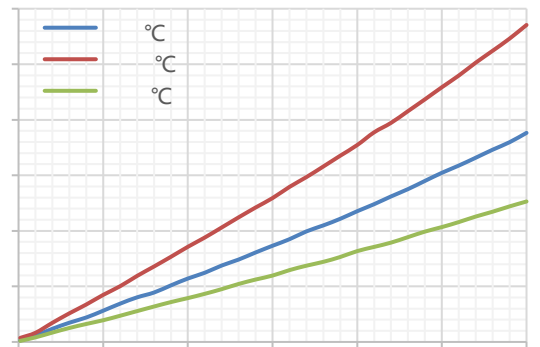



°C

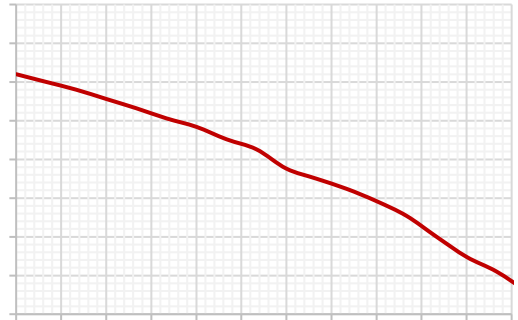

°C

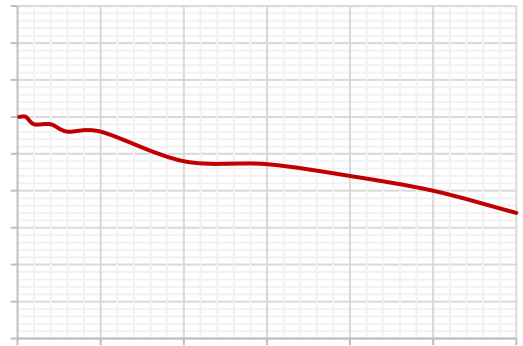
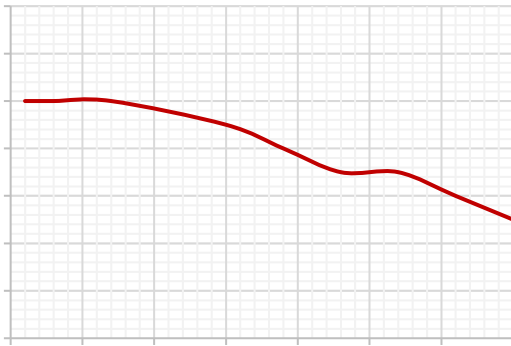

°C



°C

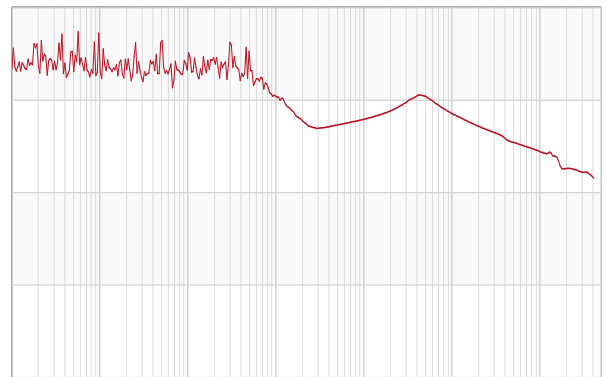
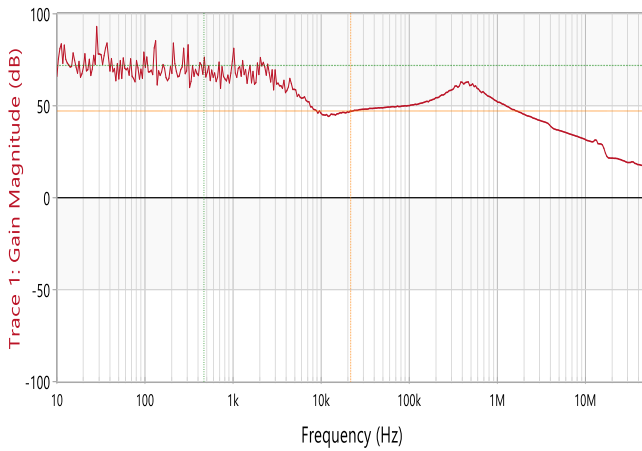
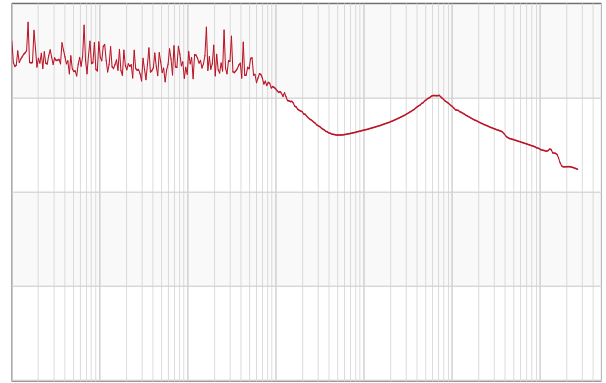
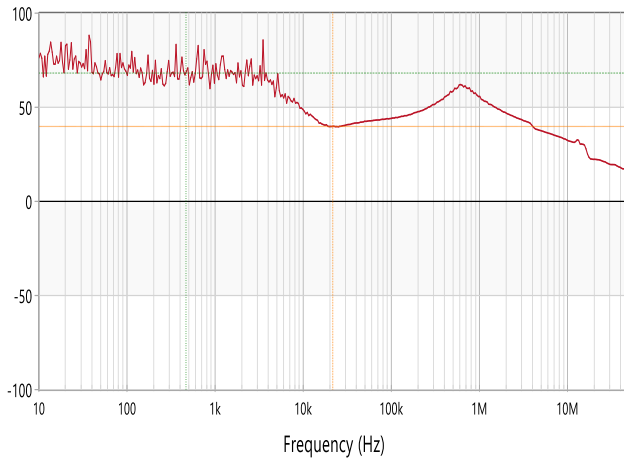
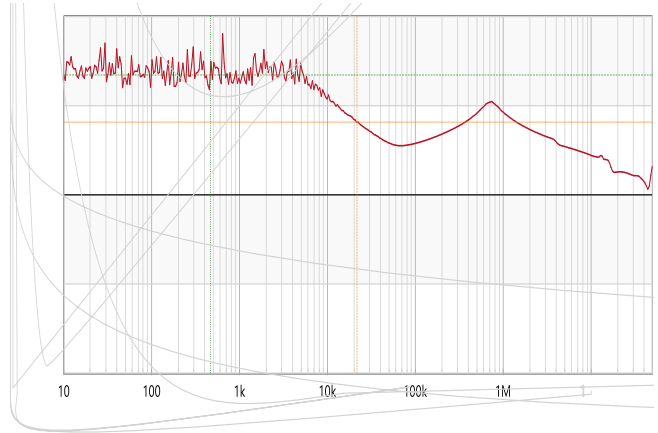
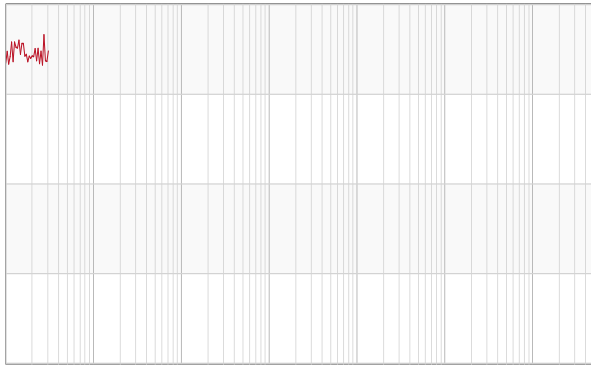

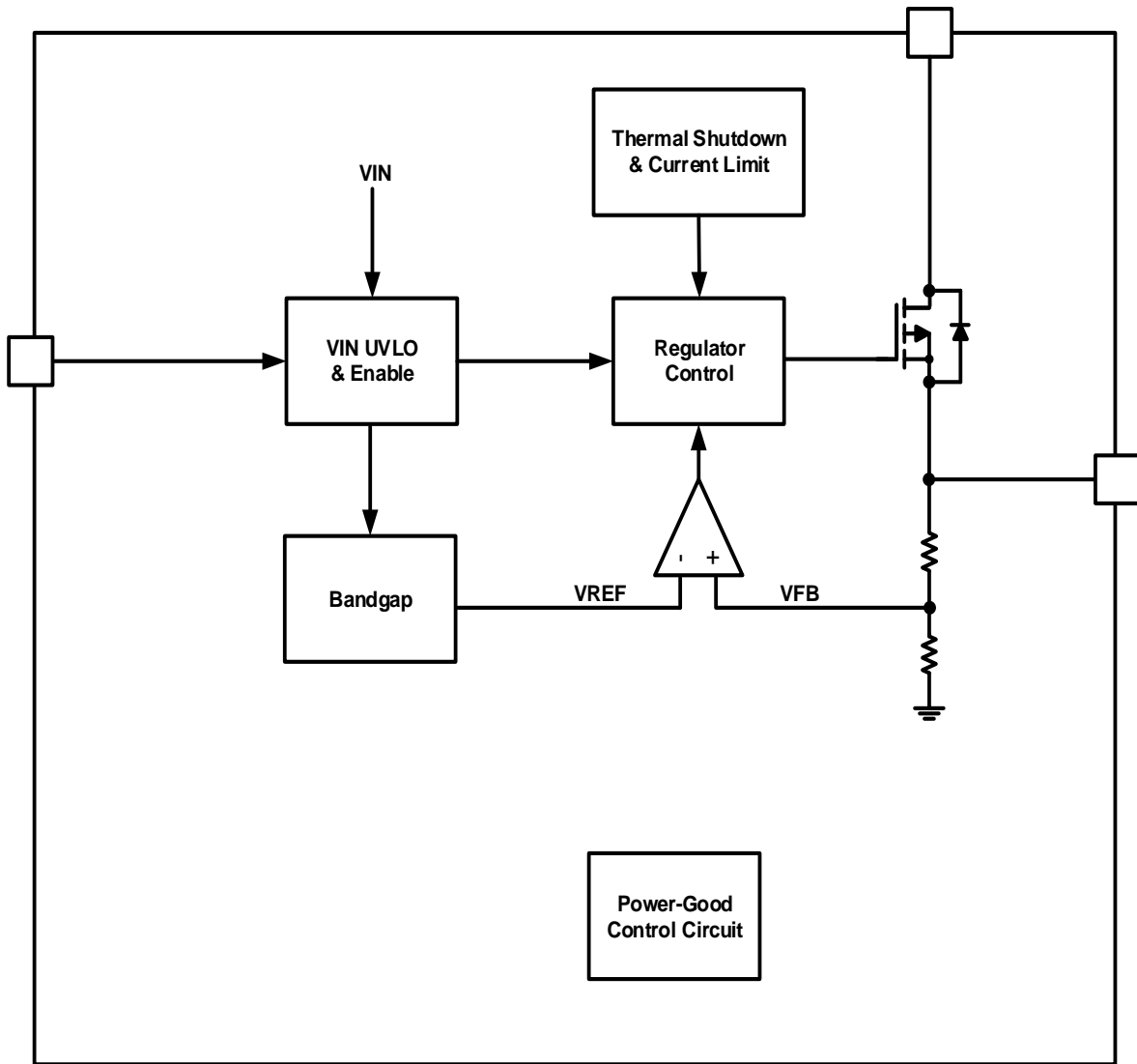

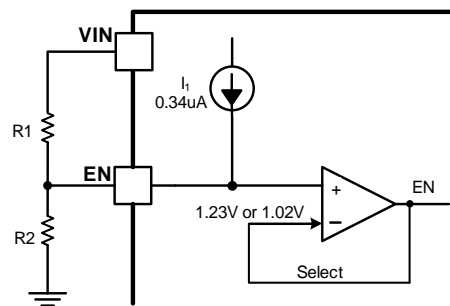

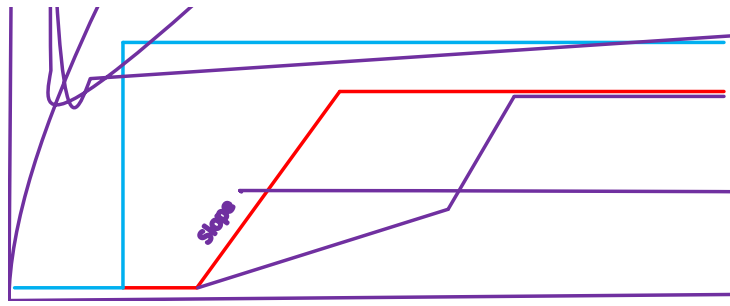

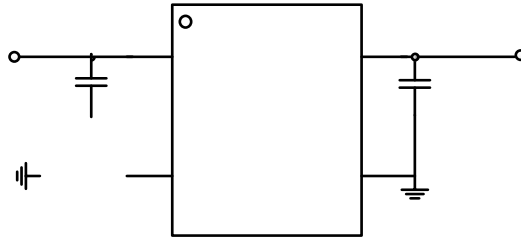

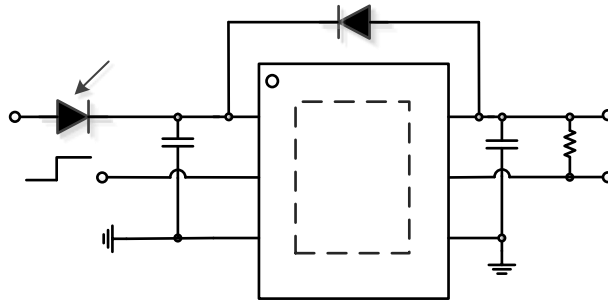

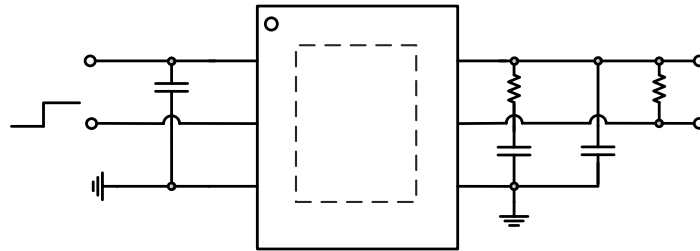

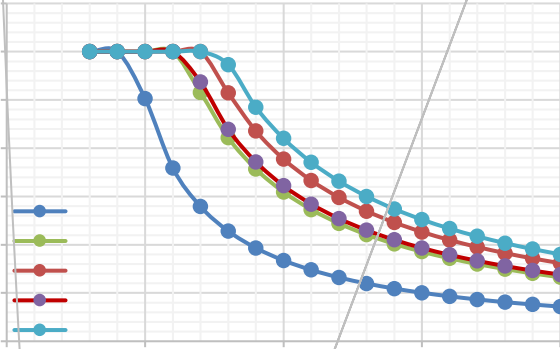

°C

°C

°C

°C



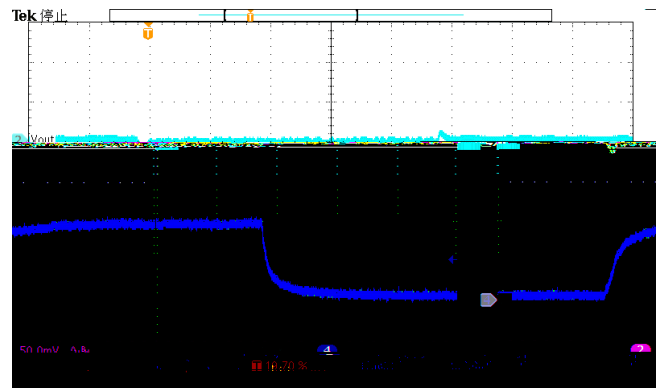
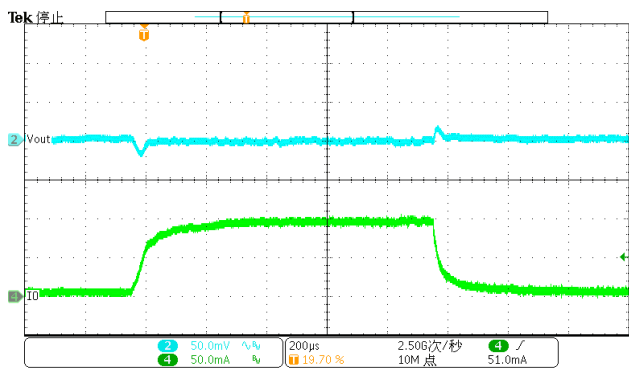
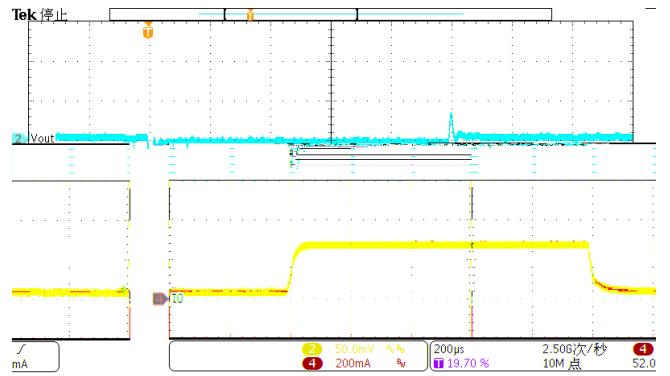
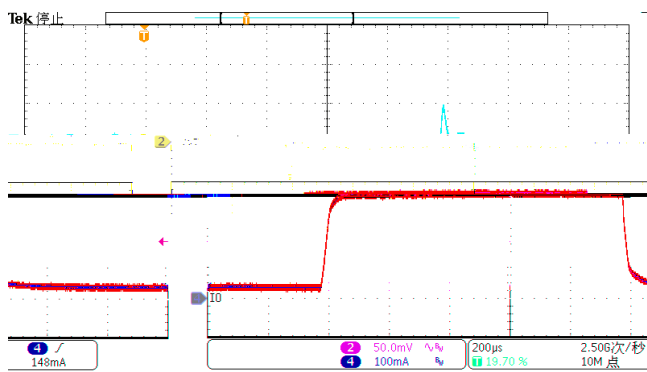
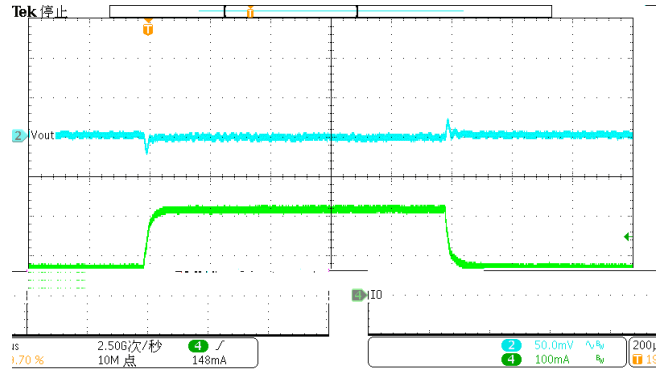
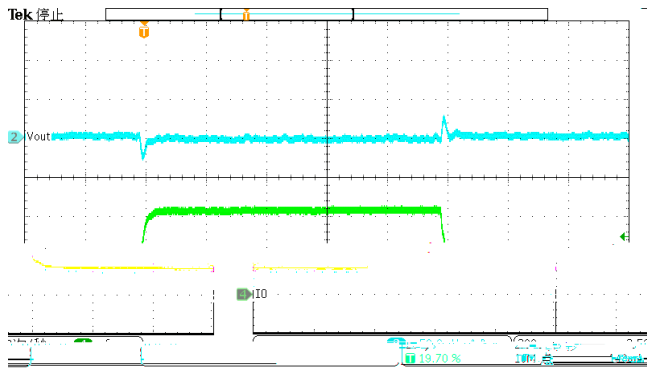

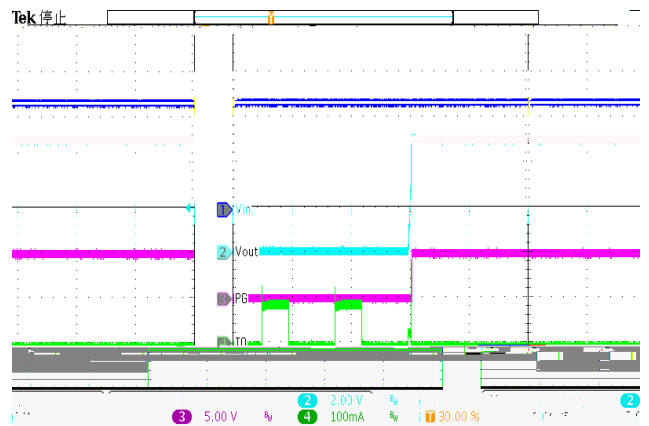
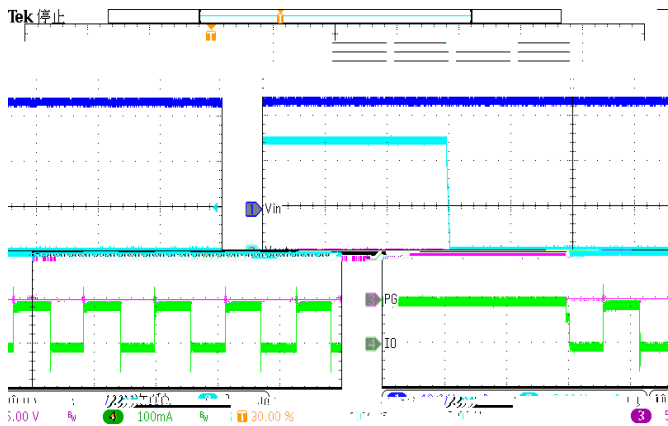
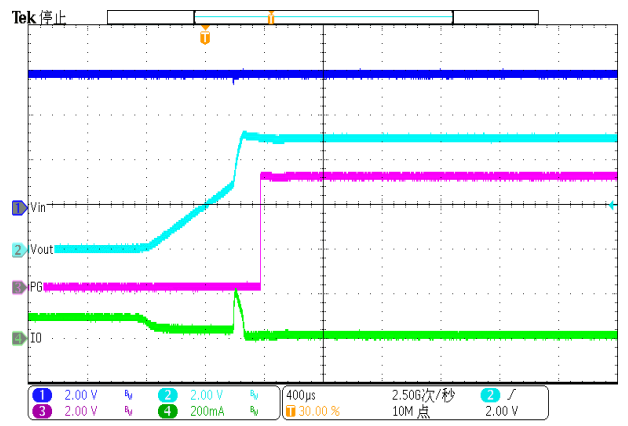
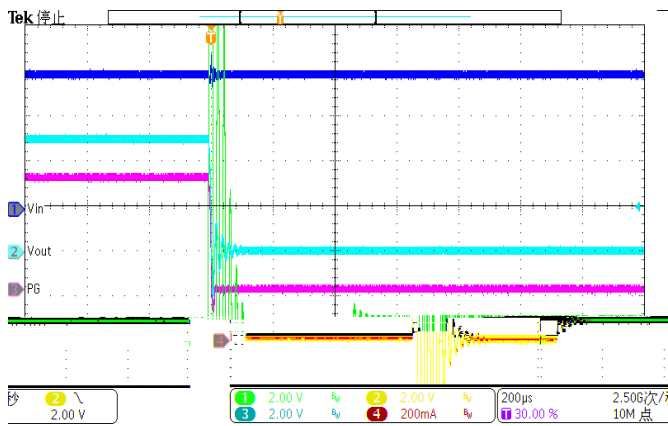
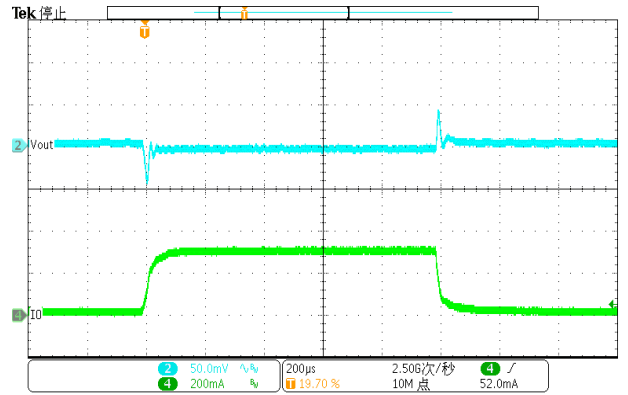
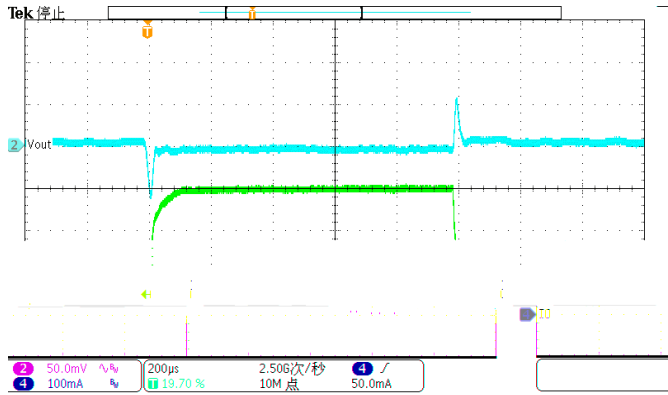

- 1.
- 2.
- 3.
- 4.
- 5.

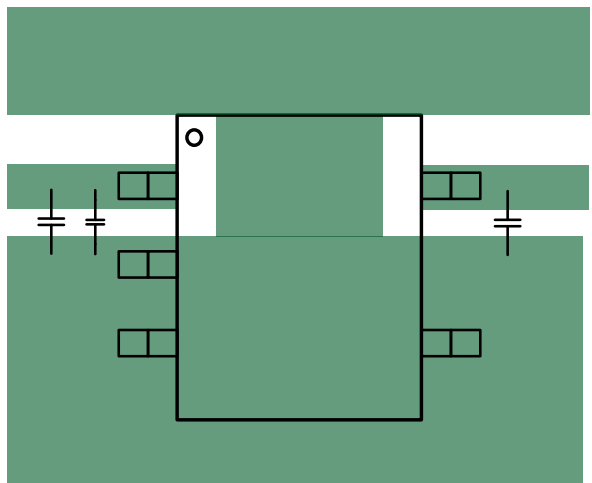
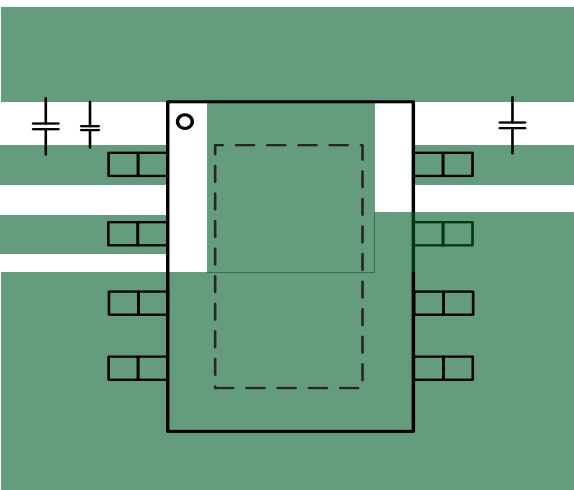
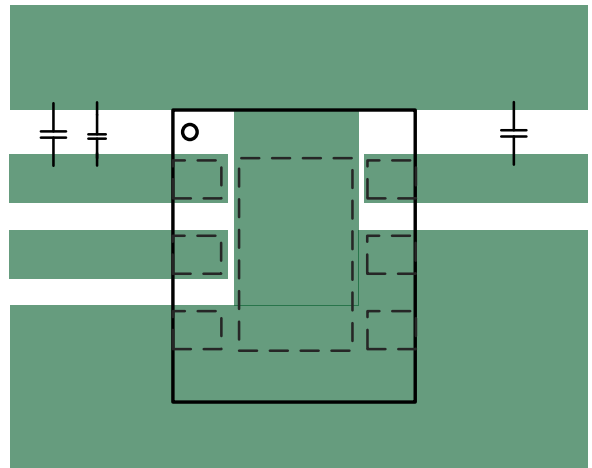
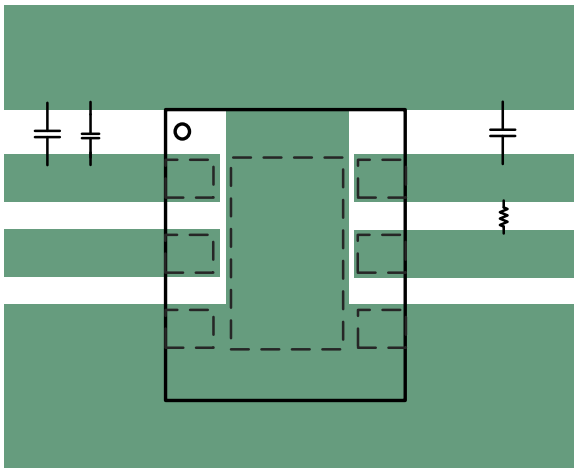

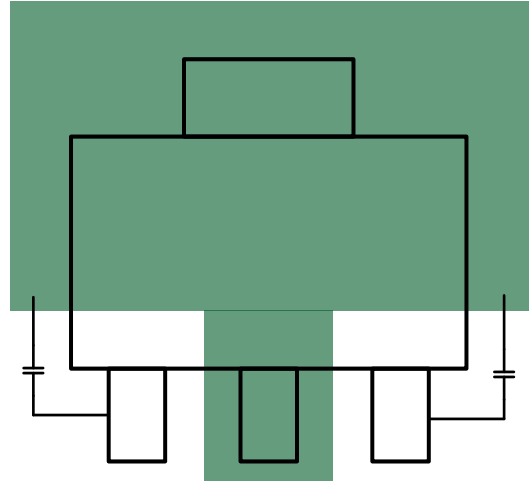
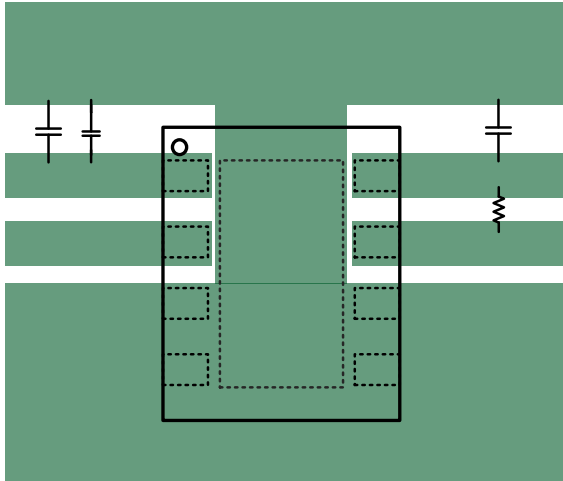

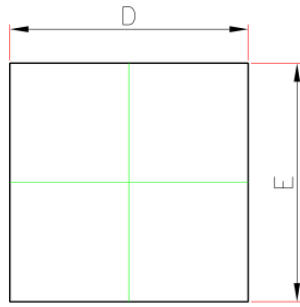

TOP VIEW

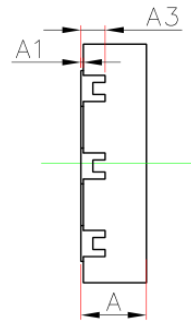

SIDE VIEW

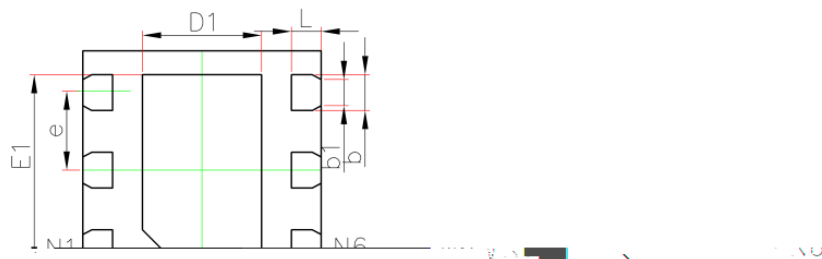

BOTTOM VIEW

- 1.
- 2.
- 3.
- 4.
- 5.
- 6.

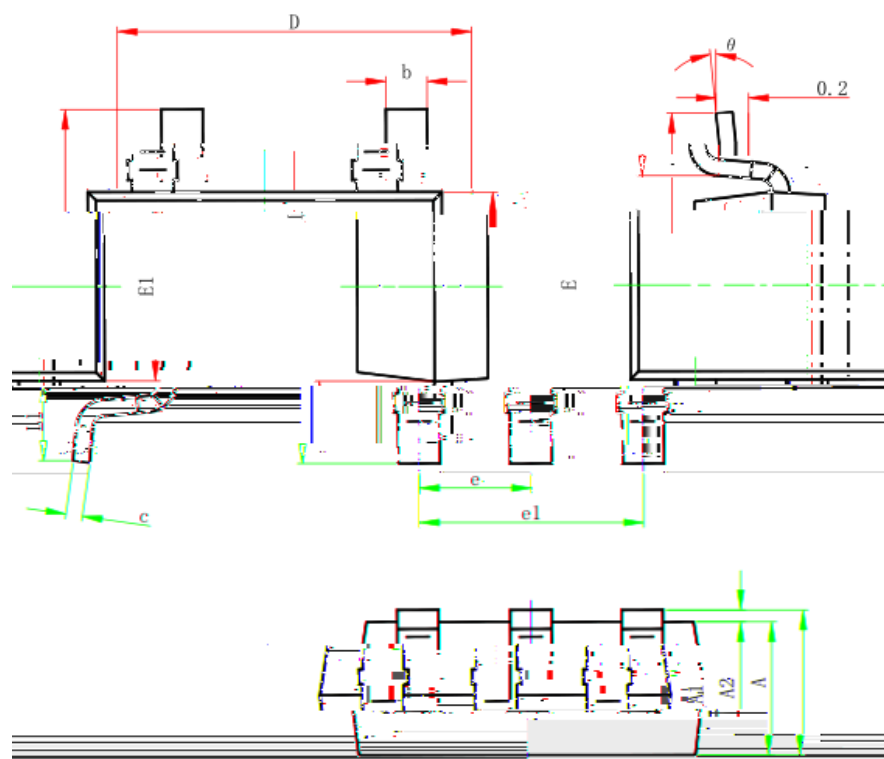

- 1.
- 2.
- 3.
- 4.
- 5.
- 6.

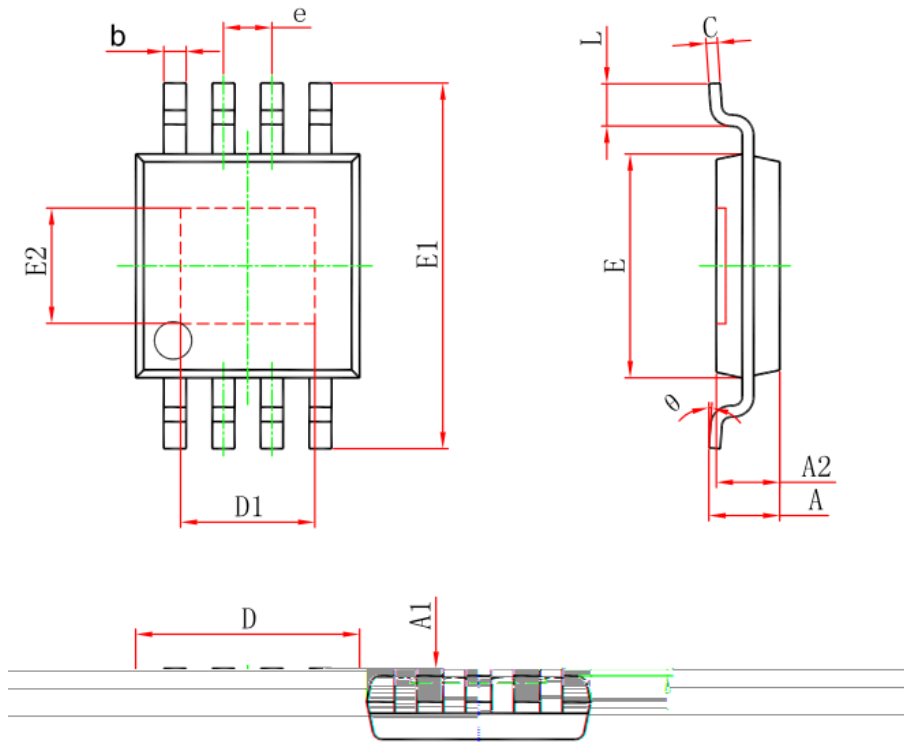

- 1.
- 2.
- 3.
- 4.
- 5.
- 6.

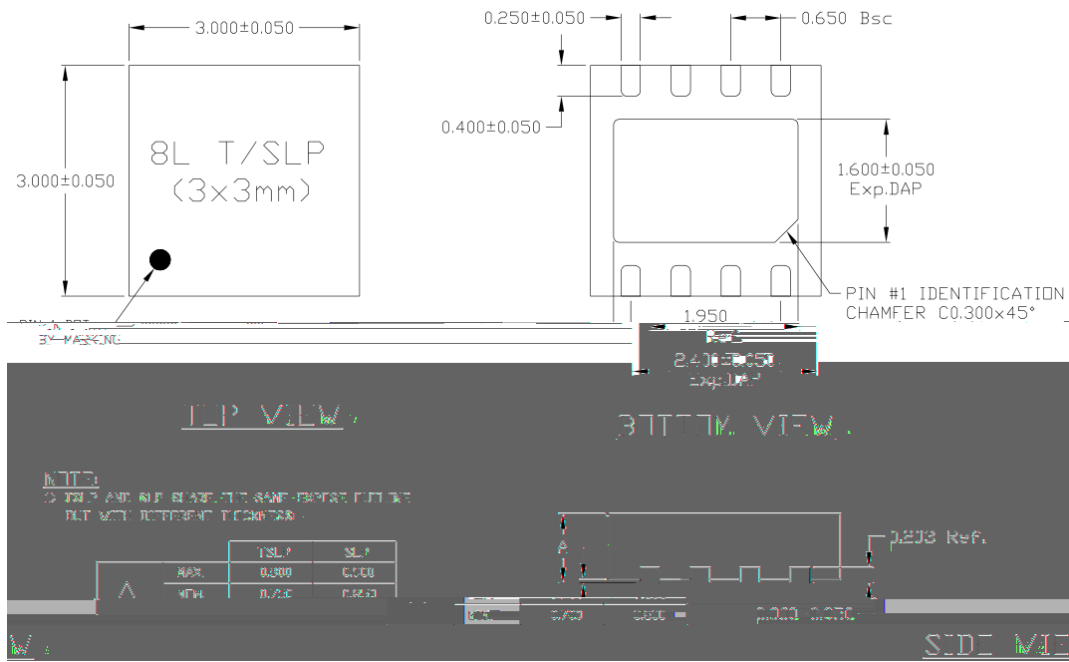

- 1.
- 2.
- 3.
- 4.
- 5.
- 6.



--	--	--	--	--	--



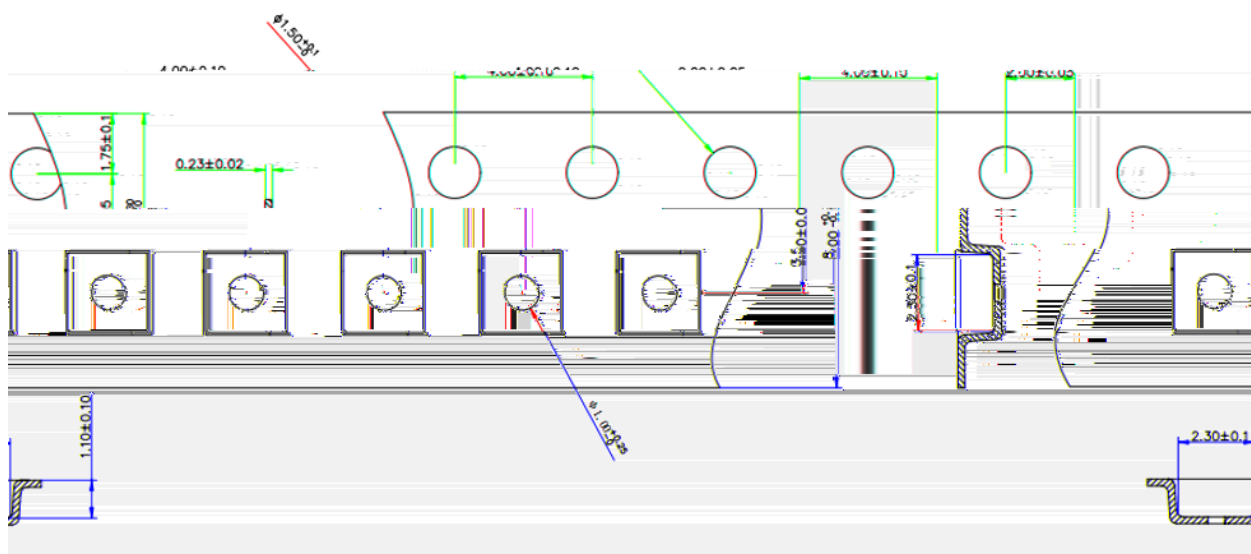
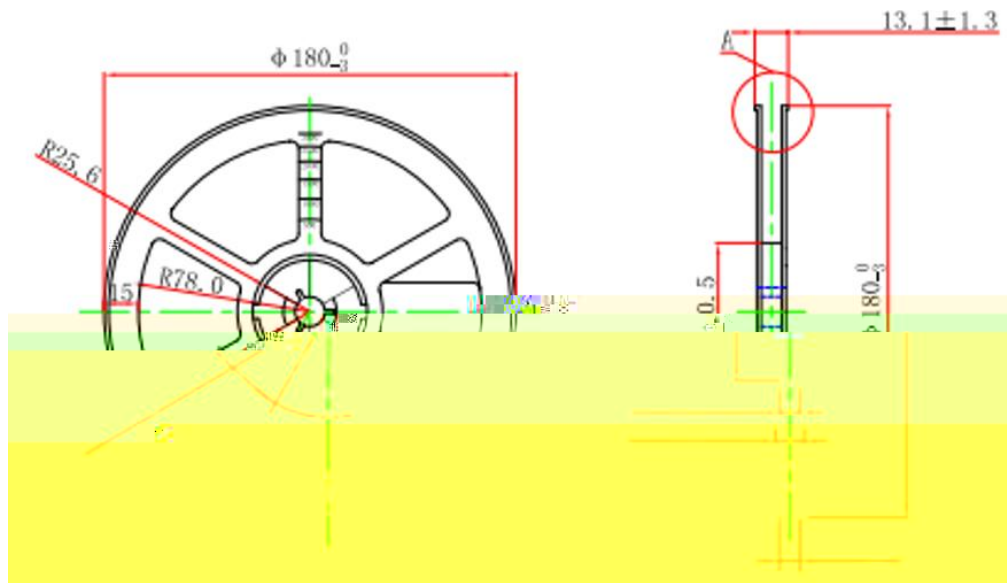

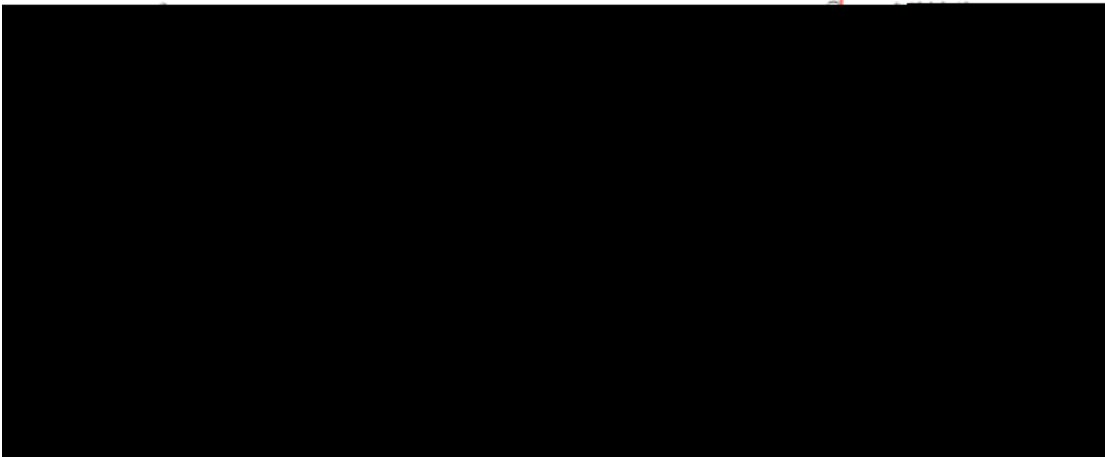
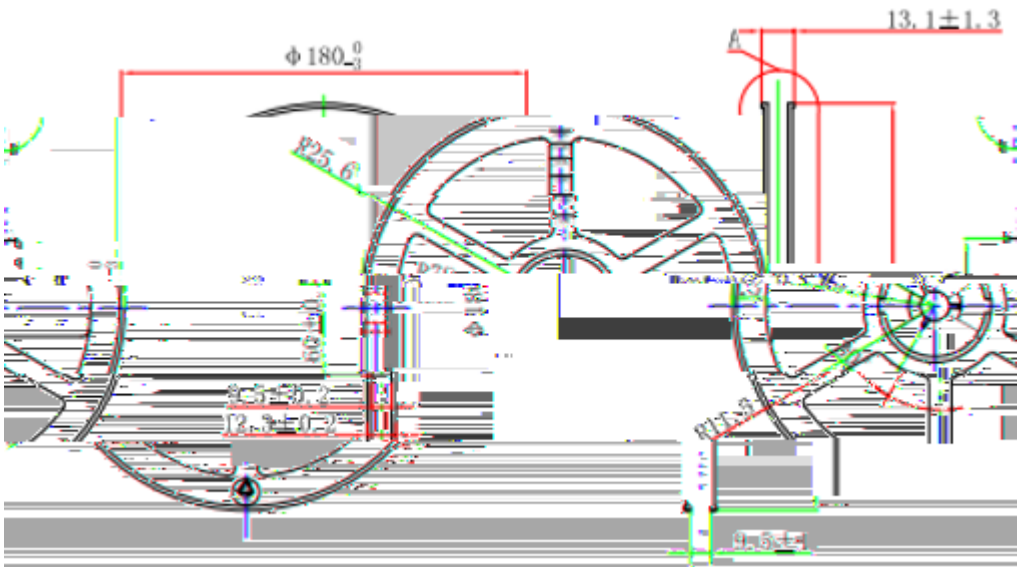

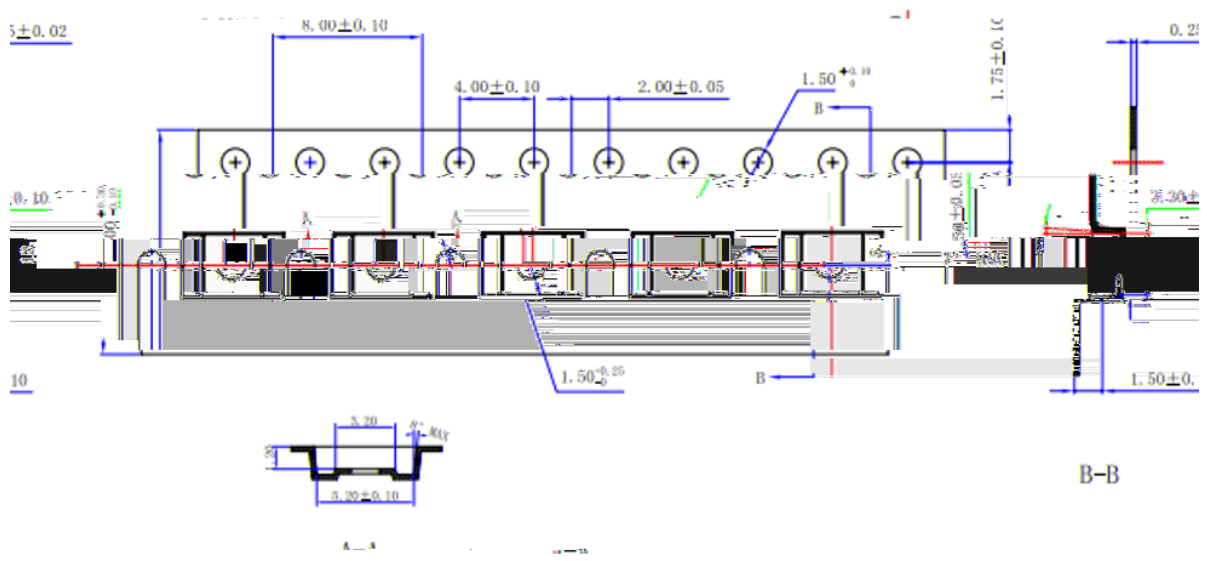
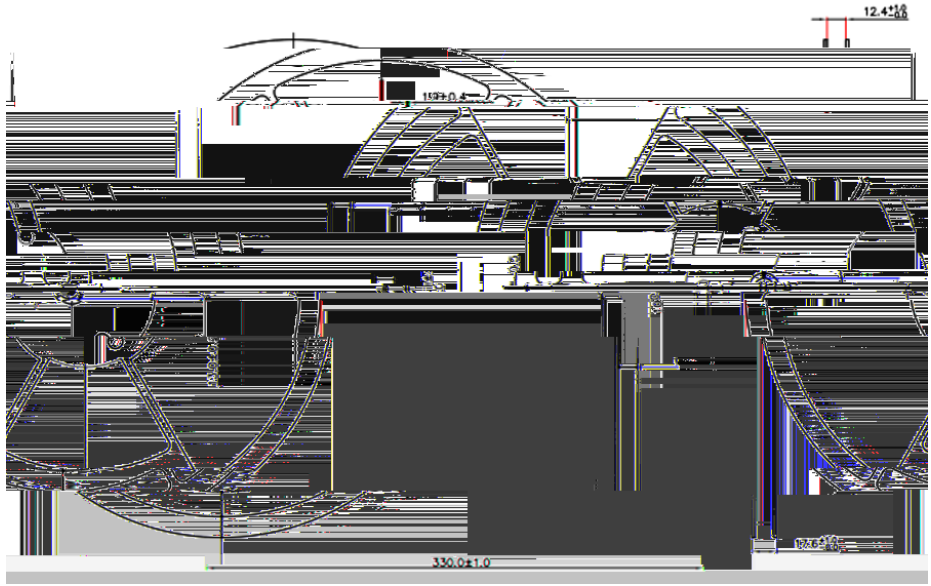

--	--	--	--

